

# HIZERO

All in One Bionic Floor Cleaner

USER MANUAL

EN



## IMPORTANT SAFETY INSTRUCTIONS

When using an electrical appliance, basic precautions should always be followed, including the following:

### READ ALL INSTRUCTIONS

### BEFORE USING (THIS APPLIANCE)

**WARNING-**To reduce the risk of fire, electric shock, or injury:

- a) To Reduce the Risk of Fire due to internal component damage, use only HIZERO cleaning fluid intended for use with the appliance. See the Cleaning Fluid section of this manual. To Reduce the Risk of Fire, do not use a flammable or combustible liquid to clean a floor.
- b) For household use only. Do not use outdoors.
- c) Do not allow to be used as a toy. Close attention is necessary when used by or near children.
- d) Use only as described in this manual. Use only manufacturer' s recommended attachments.
- e) Do not use with damaged cord or plug. If appliance is not working as it should, has been dropped, damaged, left outdoors, or dropped into water, return it to service center.
- f) Do not pull or carry by cord, use cord as a handle, close a door on cord, or pull cord around sharp edges or corners. Do not run appliance over cord. Keep cord away from heated surfaces.
- g) Do not unplug by pulling on cord. To unplug, grasp the plug, not the cord.
- h) Do not handle plug or appliance with wet hands.
- i) Do not put any object into openings. Do not use with any opening blocked; keep free of dust, lint, hair, and anything that may reduce air flow.
- j) Keep hair, loose clothing, fingers, and all parts of body away from openings and moving parts.
- k) Turn off all controls before unplugging.
- l) Use extra care when cleaning on stairs.
- m) Do not use to pick up flammable or combustible liquids, such as gasoline, or use in areas where they may be present.
- n) Prevent unintentional starting. Ensure the switch is in the off-position before connecting to battery pack, picking up or carrying the appliance. Carrying the appliance with your finger on the switch or energizing appliance that have the switch on invites accidents.
- o) Disconnect the battery pack from the appliance before making any adjustments, changing accessories, or storing appliance. Such preventive safety measures reduce the risk of starting the appliance accidentally.
- p) Recharge only with the charger specified by the manufacturer. A charger that is suitable for one type of battery pack may create a risk of fire when used with another battery pack.
- q) Use appliances only with specifically designated battery packs. Use of any other battery packs may create a risk of injury and fire.
- r) When battery pack is not in use, keep it away from other metal objects, like paper clips, coins, keys, nails, screws or other small metal objects, that can make a connection from one terminal to another. Shorting the battery terminals together may cause burns or a fire.
- s) Under abusive conditions, liquid may be ejected from the battery; avoid contact. If contact accidentally occurs, flush with water. If liquid contacts eyes, additionally seek medical help. Liquid ejected from the battery may cause irritation or burns.
- t) Do not use a battery pack or appliance that is damaged or modified. Damaged or modified batteries may exhibit unpredictable behavior resulting in fire, explosion or risk of injury.
- u) Do not expose a battery pack or appliance to fire or excessive temperature. Exposure to fire or temperature above 130°C may cause explosion. The temperature of 130°C may be replaced by the temperature of 265°F.
- v) Follow all charging instructions and do not charge the battery pack or appliance outside of the temperature range specified in the instructions. Charging improperly or at temperatures outside of the specified range may damage the battery and increase the risk of fire.
- w) Have servicing performed by a qualified repair person using only identical replacement parts. This will ensure that the safety of the product is maintained.
- x) Do not modify or attempt to repair the appliance or the battery pack (as applicable) except as indicated in the instructions for use and care.

## Quick Start Guide

### Assembly

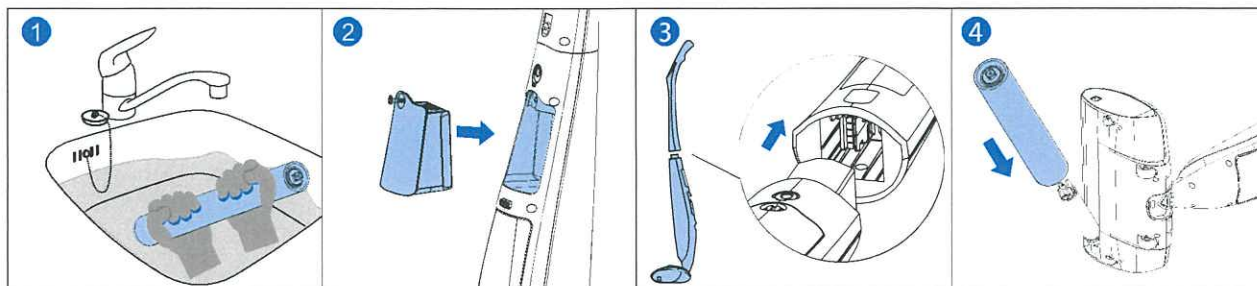

① Saturate polymer roller until wet

② Install the battery

③ Connect the handle

④ Install Polymer roller

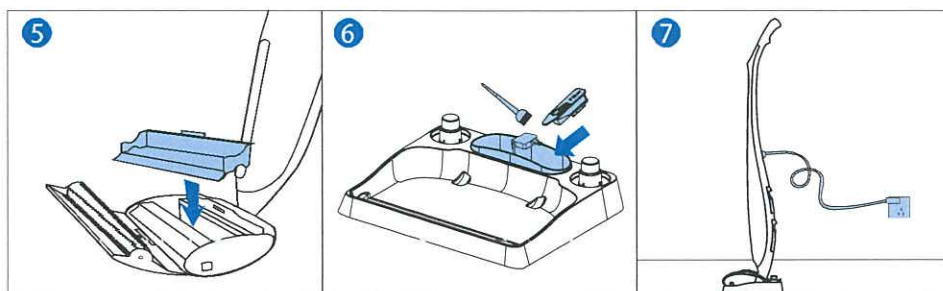

⑤ Install solid waste tray

⑥ Store the accessories

⑦ Charge

### How to Operate

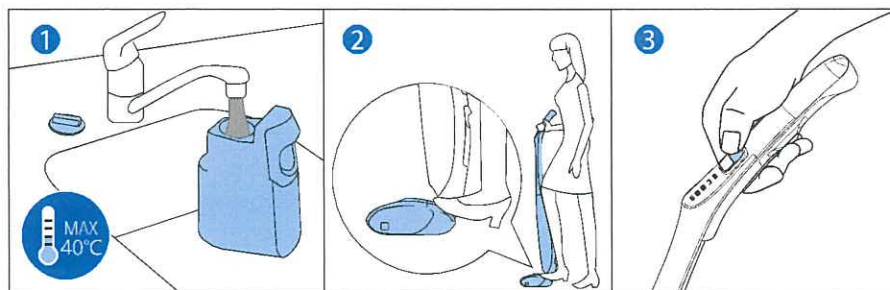

① Fill the clean water tank

② Unlock the appliance

③ Press to start

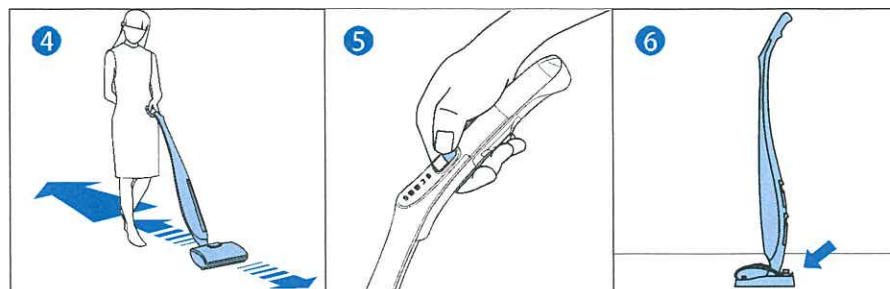

④ Move to clean

⑤ Power Off

⑥ Store on the base dock

## Cleaning

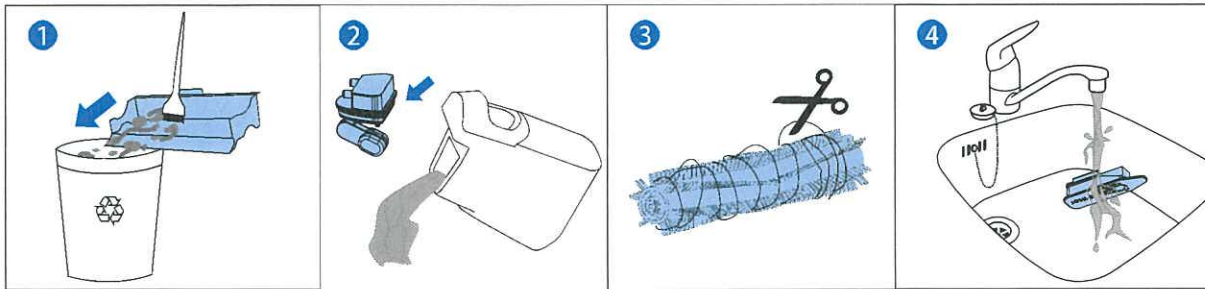

① Remove solid waste from tray

② Remove dirty water

③ Clean brush roller

④ Wash mini filter (Green One)

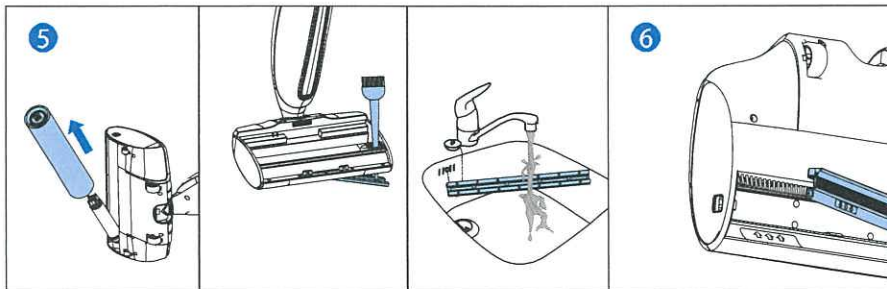

⑤ Take out the grate and wash

⑥ Install the grate

## Storage

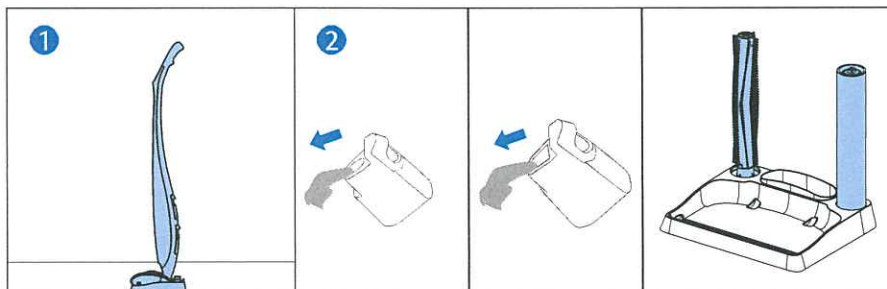

① Daily storage

② Long-term storage

## Warning

In the event of the polymer roller coming into contact with these liquids, remove it and run it under clean water.

1. Highly concentrated alcohol, such as liquor, whiskey, etc.
2. Strong acids, such as vinegar.
3. High-concentration oxidants, such as 84 disinfectant, bleach, etc.
4. Strong alkaline substances, such as washing powder.
5. Other degreaser products, such as toilet cleaner, grease cleaning solution, etc.

Charge, use, and store the product in an environment with the temperature range of 10-40°C.

For use only with F8Z-BTA06 battery.

For use only with K25V240100U charger.

<b>1. Safety Instructions</b>	<b>01</b>
<b>2. Product Overview</b>	<b>03</b>
<b>3. Control Panel</b>	<b>04</b>
<b>4. Assembly</b>	<b>04</b>
<b>5. Preparation</b>	<b>06</b>
<b>6. Operation</b>	<b>07</b>
<b>7. Maintaining &amp; Cleaning</b>	<b>09</b>
<b>8. Storing &amp; Moving</b>	<b>11</b>
<b>9. Replacing accessories</b>	<b>11</b>
<b>10. Caring for the Environment</b>	<b>12</b>
<b>11. Specifications</b>	<b>12</b>
<b>12. Warranty &amp; After-sales</b>	<b>13</b>
<b>13. Troubleshooting</b>	<b>14</b>

Thank you for choosing the HIZERO All in One Bionic Floor Cleaner and congratulations for making the right choice to have crystal clean floors with less effort! Harnessing patented game-changing bionic technology, your Hizero integrates the functions of sweeping, mopping, and drying stone, wood, cork and laminate hard floors. Your cleaner has a built in rechargeable battery to give you all the freedom-of-movement benefits of wireless cleaning, while the self-cleaning polymer cleaning roller automatically separates solid and liquid dirt and messes into separate trays. You can now enjoy high cleaning efficiency, simple operation and easy maintenance. This user manual also provides you useful tips about how to get the most out of your Hizero floor cleaner for a cleaner, healthier and easier lifestyle, so we suggest you read it through carefully and keep handy for future reference.

## 1. Safety Instructions



### 1.1 Warning

For the purposes of recharging the battery, only use the detachable supply unit provided with this appliance.

Do not move Hizero over the following:

- Electrical cables
- Parts of the human body
- Large solid objects

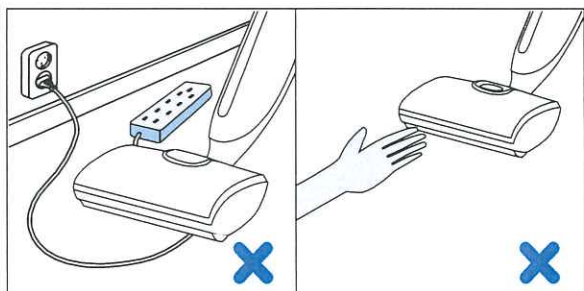

### 1.2 Caution

- Remove product from docking station, prior to operating or maintaining it.
- Always switch off prior, before removing water tanks or opening the cleaning head.
- To avoid damaging: do not use to clean up broken glass or sharp objects.
- Do not immerse or rinse the body under water. As this will cause irreparable damage.
- Never use the product to clean flammable or combustible liquids and do not put flammable or combustible liquids in the clean/dirty water tank.
- Regularly maintain the product, if damaged take it to an authorized service center.
- This appliance can be used by children aged from 8 years and above and persons with reduced physical, sensory or mental capabilities or lack of experience and knowledge if they have been given supervision or instruction concerning use of the appliance in a safe way and understand the hazards involved.
- Children shall not play with the appliance.
- Cleaning and user maintenance shall not be made by children without supervision.
- Never store the product at a temperature lower than 0°C/32°F.
- Only use clean water with or without Hizero cleaning solution, in the clean water tank.
- Do not put anything acidic (example vinegar), or not Hizero authorized detergents, in the water tanks. Both the clean or dirty water tanks.
- Do not use wax, oil or floor maintenance products, in the clean water tank.
- Use HIZERO authorized batteries only!
- Charge only with Hizero docking station.
- Battery can only be used for Hizero Bionic floor cleaner, is not interchangeable with other products. Do not expose the battery to heat (50°C/122°F), water or the outdoors.
- Do not allow the battery terminals to touch any metal objects. Thus avoiding any thermal effect, smoke, fire or even explosion.
- In the event of battery leakage, cease use immediately and call a Hizero authorized service centre.
- Batteries should be replaced by skilled technicians.
- Discard non functioning batteries, as regulated by your country of origin.
- Use only HIZERO specified cleaning solution to prevent any damage to internal components.
- Do not clean the polymer roller, with sharp objects. As this will damage it and reduce the cleaning performance.
- Do not clean the polymer roller, with sharp objects. As this will damage it and reduce the cleaning performance.
- When there is water in either of the water tanks, never put the product on its side or upside down in order to prevent any leakages.
- Empty the dirty water tank after use, to prevent bacteria and odor buildup.
- No removable can be cleaned in a dishwasher or washing machine.
- This product is intended for the indoor use only (not outdoor use).

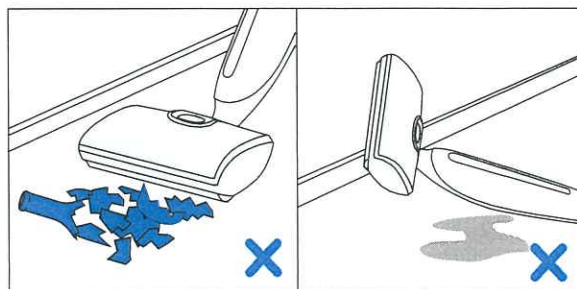

### 1.3 Compliance

This product complies with the current recognized electrical product technical specifications and safety regulations. It is safe to use the product if the user operates according to the instructions of this user manual.

### 1.4 Self-Protection System

This product will automatically stop, if a large object is caught in the polymer roller.

### 1.5 Intended Use

This product is designed to be used on waterproof hard flooring.  
(eg Tiles/Wood/Concrete/Marble)

Not to be used on carpets or any water absorbent floor coverings.

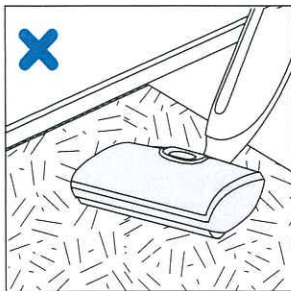

### 1.6 Best Results

Please use this use and care guide in conjunction with any manuals you may have for your floor to obtain the best result. Hizeo only recommends our cleaning solution to enhance your result.

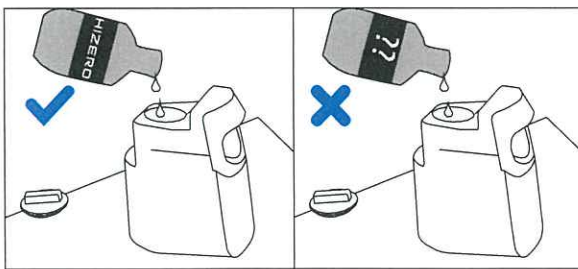

 : detachable supply unit

 : read operator's manual

 : This marking indicates that this product should not be disposed with other household wastes throughout the EU. To prevent possible harm to the environment or human health from uncontrolled waste disposal, recycle it responsibly to promote the sustainable reuse of material resources. To return your used device, please use the return and collection systems or contact the retailer where the product was purchased. They can take this product for environmental safe recycling.

This device must accept any interference received, including interference that may cause undesired operation.

Please note that changes or modifications of this product is not expressly approved by the party responsible for compliance could void the user's authority to operate the equipment.

Note: This equipment has been tested and found to comply with the limits for a Class B digital device, pursuant to Part 15 of the FCC Rules. These limits are designed to provide reasonable protection against harmful interference in a residential installation. This equipment generates, uses and can radiate radio frequency energy and, if not installed and used in accordance with the instructions, may cause harmful interference to radio communications. However, there is no guarantee that interference will not occur in a particular installation.

If this equipment does cause harmful interference to radio or television reception, which can be determined by turning the equipment off and on, the user is encouraged to try to correct the interference by one or more of the following measures:

- Reorient or relocate the receiving antenna.
- Increase the separation between the equipment and receiver.
- Connect the equipment into an outlet on a circuit different from that to which the receiver is connected.
- Consult the dealer or an experienced radio/TV technician for help.

## 2. Components in the box

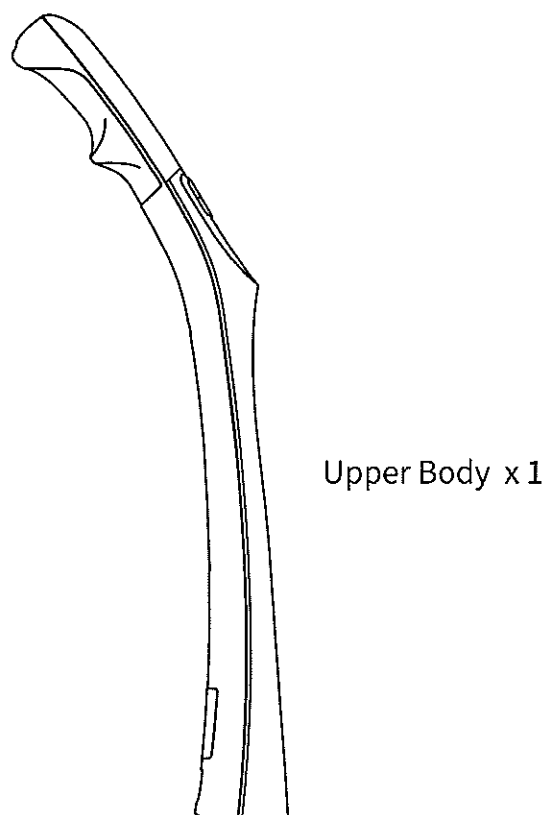

Upper Body x 1

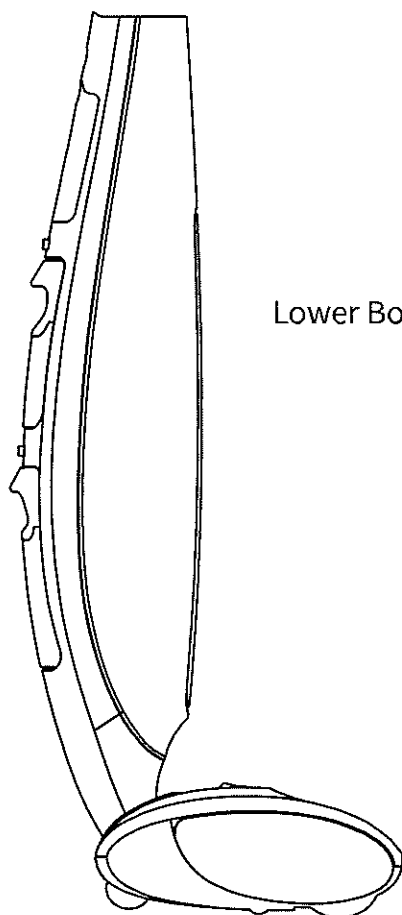

Lower Body x 1



Quick-Mount Screw x 1



Battery x 1



Clean Water Tank x 1



Dirty Water Tank x 1



Cleaning Roller x 1



Trash Container x 1



Brush Roller x 1

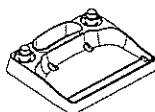

Base Dock x 1



Power Adapter x 1



Comb Filter  
Assembled x 1  
Spare x 3



Cleaning Brush x 1



User Manual x 1



HIZERO Clean Solution x 1  
(Optional)



### 3. Control Panel

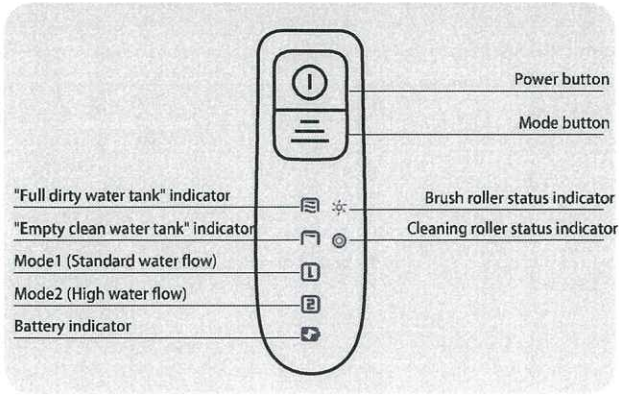

#### 3.1 Charging

- Flashing Red:** The product is charging.
- Solid Blue:** The product is fully charged.

#### 3.2 In Use

- Flashing red:** Low battery warning.
  - Solid Red:** Extremely low battery, the product will automatically power off within 3 minutes.
  - Solid Blue:** Sufficient power.
- 
- Mode 1:** Normal mode, the appliance will use less water. A full tank (500ml) of clean water can last for approximately 10 minutes (should be used for regular clean).
- 
- Mode 2:** High water flow mode, the appliance will use more water. A full tank (500ml) of clean water can last for approximately 5 minutes (half the time).
- 
- Flashing:** The water in the clean water tank is running low. The product will stop working and automatically switch-off after 30 seconds.
  - Solid Red:** Please contact Customer Service.
- 
- Flashing:** A. The dirty water tank is full.  
B. The dirty water tank is not assembled correctly.
  - Solid Red:** Please contact Customer Service.
- 
- Flashing:** Please contact Customer Service.

- Flashing:** The cleaning head lid is not closed properly.

- Solid Blue:** Normal working mode.
- Solid Red:** Error. Please check the control panel for more information.

### 4. Assembly

- Before installing, immerse the polymer roller in water until soft, make sure the water does not exceed 50°C (See images below). Once soft, remove any excess water and install.

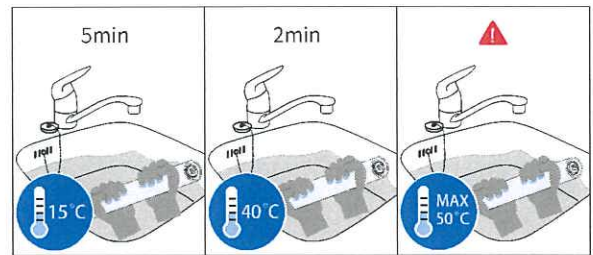

- Open the cover by pressing the silver button located on top. Once open remove the green waste container.

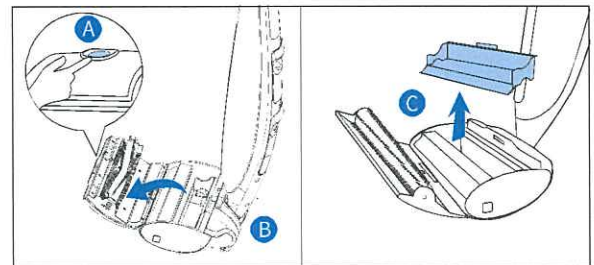

- Close the top cover, and lay the Hizero on it's side, making sure polymer roller release button is facing upwards.

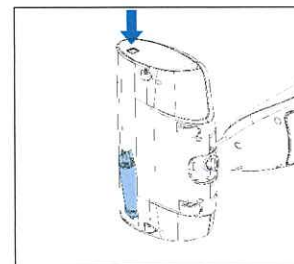

- ④ Insert the cleaning roller onto the drive motor (note: the maximum opening angle of the drive motor is  $45^\circ$ ), gently push and fix it into the cleaning head till the release button is in place.

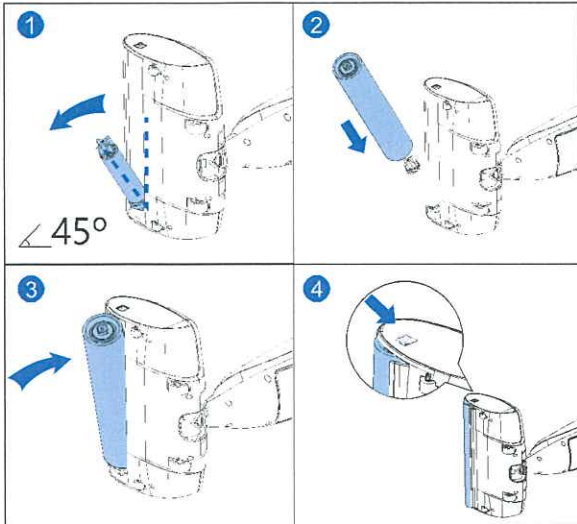

- ⑤ Place the lower body in upright position, open the cleaning head lid, insert the container and press it into place. Close the lid until you hear a click to ensure the lid is closed properly.

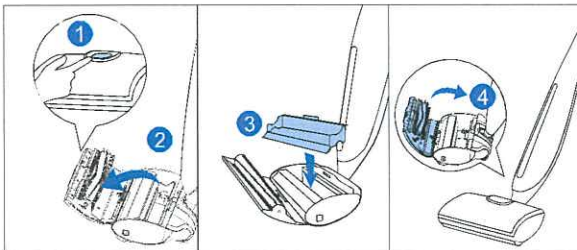

- ⑥ Push the lower body forward lightly until you hear a click which means the product is locked in upright position.

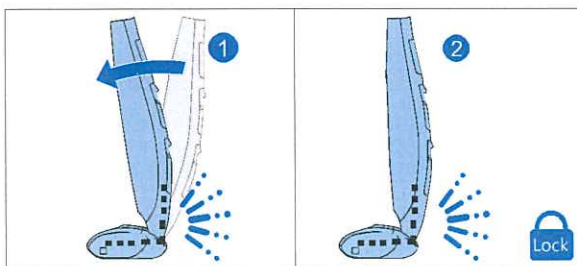

- ⑦ Take out the handle and remove the body quick-mount screw first. Then gently insert the handle onto the lower body and make sure the handle and the lower body of the appliance are connected firmly.

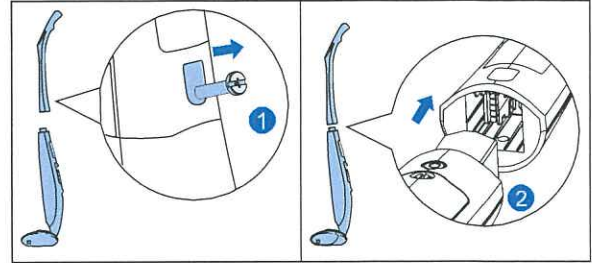

- ⑧ Once handle is inserted, insert screw and tighten clockwise (as per image 4).

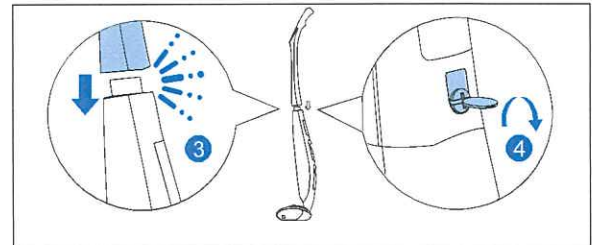

- ⑨ • Insert battery into the first opening of the main body.  
• Fasten screw and tighten clockwise (as per image 2).

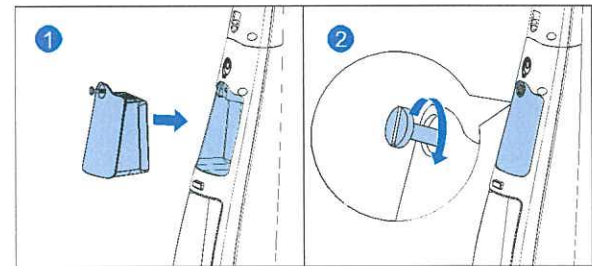

**Note:** If the appliance fails to start after the connection, please retry inserting the handle onto the lower body and restart the appliance.

## 5. Preparing for use

### 5.1 Charging

Plug the power adapter to the charging port of the product.

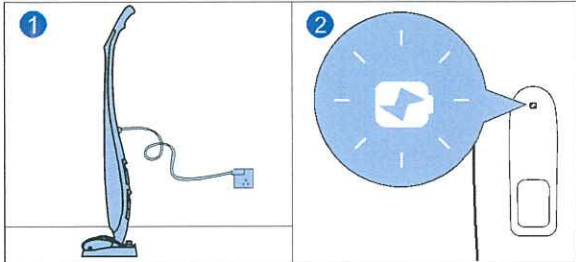

### 5.2 Remove Large Objects from the Floor

Before using the product, please remove large objects such as toys, power cords and shoes from the floor to be cleaned.

### 5.3 Fill the Clean Water Tank

Fill the clean water tank before every use.

- 1 Press the release button to remove the tank. To prevent the product from toppling over, hold it upright with one hand and take out the clean water tank with the other hand.

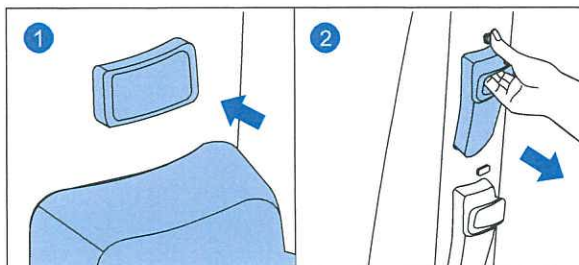

- 2 To fill clean water tank, simply turn the lid anti clockwise. Fill with only cold or warm water (maximum 40°C), capacity is 500ml. Hizeero cleaning solution may also be added (Refer to section 1.6 Floor Maintenance).

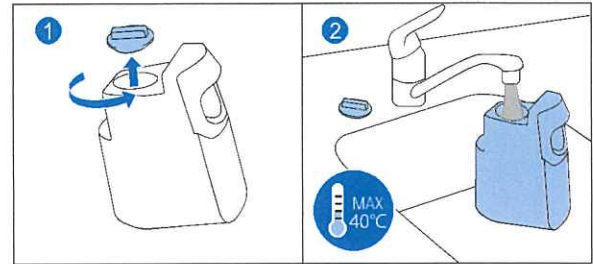

**Note:** Only use Hizeero Cleaning solutions.

- 3 Turn the cap clockwise until it is tight, and re-install. (As per images 1 and 2.) If not installed correctly it will not work.

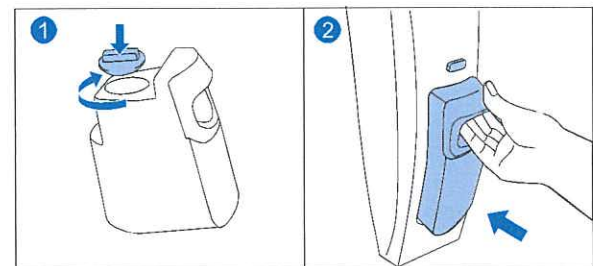

**Note:** To avoid the water tank from sliding out during cleaning, please make sure it is locked in when you hear a click.

### 5.4 Locking the Body

Hold the handle of the product, push it forward lightly until you hear a click which means the product is locked vertically. Do not push it any further, or the product will be damaged.

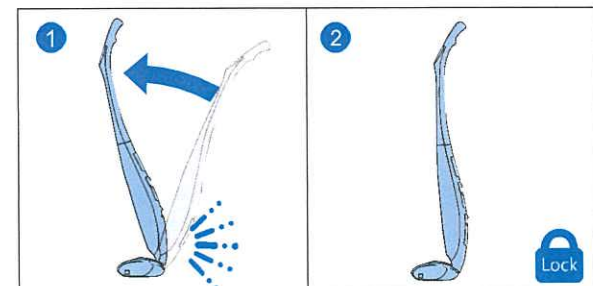

## 6. Operation

### 6.1 Start the Product

Lift off the base, hold both the handle and the cleaning head. Place one foot on the cleaning head, when off the base and on solid floor. Then gently pull back on the handle to release from its locked position.

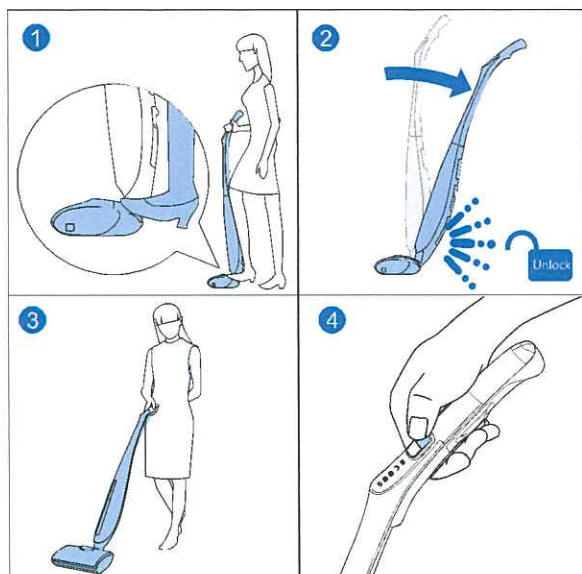

**Note:** During locking or unlocking, the clicking sound is normal.

### 6.2 Start Cleaning

- ① For the maximum cleaning effectiveness, it is recommended to remove any large solid spills, and to allow the Hizero to move forward to clean, via its motorized polymer roller.



- ② To avoid inefficient cleaning, the cleaning path shown in the following pictures is recommended.

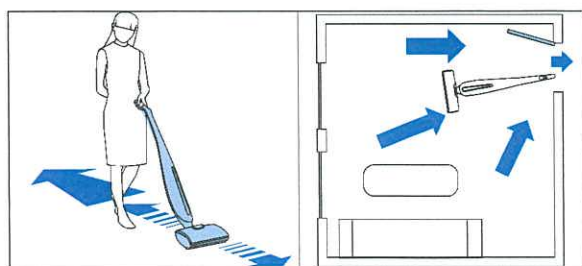

- ③ To remove stubborn stains, move the product back and forth repeatedly.  
④ Do not lay the product flat.

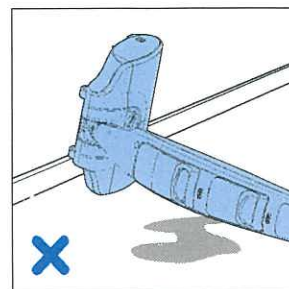

- ⑤ If the cleaning roller is jammed by foreign objects, press the power button to switch off the product immediately.

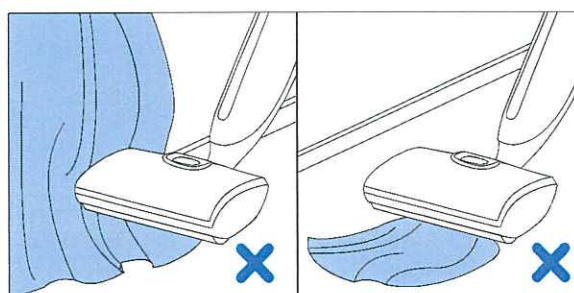

### 6.3 Water tank indication

- ① The indicator will flash red when the clean water tank is empty. Please switch off the product and fill the clean water tank ( refer to Section 5.3 Fill the Clean Water Tank). Then re-start the product.

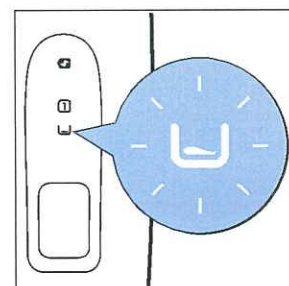

- ② The indicator will flash red and the product will stop working when the dirty water tank is full. Please empty the dirty water tank (refer to Section 6.4 Empty the Dirty Water Tank) and re-start the product.

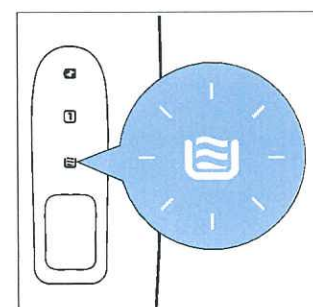

## 6.4 Empty the Dirty Water Tank

- ① Press the release button for the dirty water tank and pull it out. To prevent the product from toppling over, hold it upright with one hand and take out the dirty water tank with the other hand.

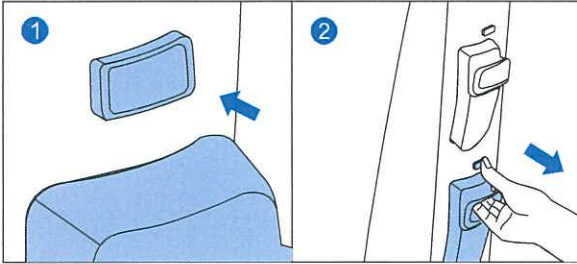

- ② To easily remove the cap of the dirty water tank, hold the cap and pull it up gently from rounded side as shown in the picture below. Slowly pour the dirty water into the drain. Pouring too fast could lead to spilling.

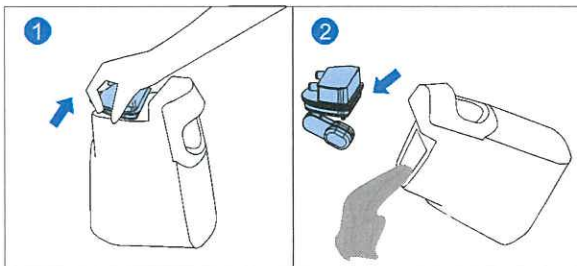

- ③ Rinse the empty dirty water tank and its cap under the tap. Then install the tank back into the product. To prevent the product from toppling over, hold it upright with one hand and install the dirty water tank with the other hand.

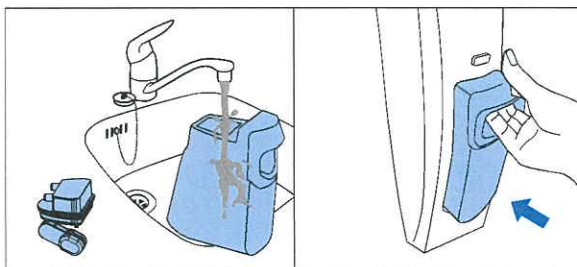

- Note:** 1. To avoid the water tank from sliding out during cleaning, make sure it is installed and locked properly.  
2. Pour dirty water out each time, after cleaning to avoid bacteria and odor build up.  
3. The waste water warning volume is about 500mL.

## 6.5 Empty the Container

Open the cleaning head lid. Take out the trash container and use the cleaning brush to sweep the trash into a dustbin.

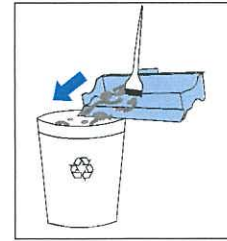

## 6.6 Automatic Protection System

The automatic protection system will automatically switch off and indicate in red something has gone wrong.

To automatically re-set and continue cleaning do the following:

- ① Open the cleaning and remove the jammed object in the roller.
- ② If this does not resolve it, remove the roller for further inspection.
- ③ After removing the obstruction re-install all removed components (As per section 9).

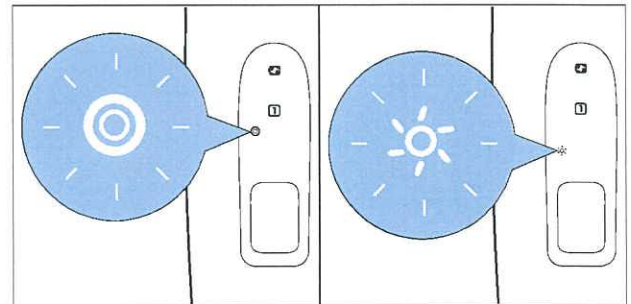

## 7. Maintenance & Cleaning



Note: The power adapter should be removed and the product should be switched off before cleaning or maintaining.

### 7.1 Maintenance

- ① Regularly clean the exterior of the product with dampened soft cloth. Do not use caustic detergents or material like steel wool, as this will cause damage to the outer body.
- ② To avoid any damage, do not immerse the product in water or any other liquid, or rinse it under the tap.
- ③ Regularly check the cleaning roller and brush roller.
- ④ Regularly check the power adapter to ensure the power cable is intact and safe to use.

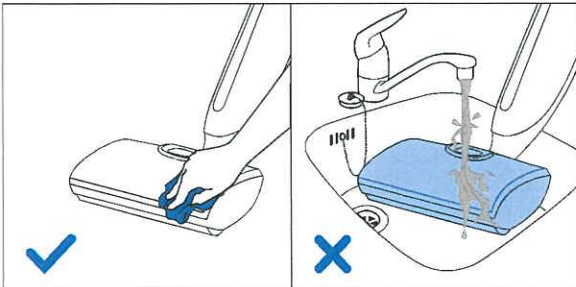

### 7.2 Clean the Water Tanks

We strongly advise you to empty the tanks before storing the product.

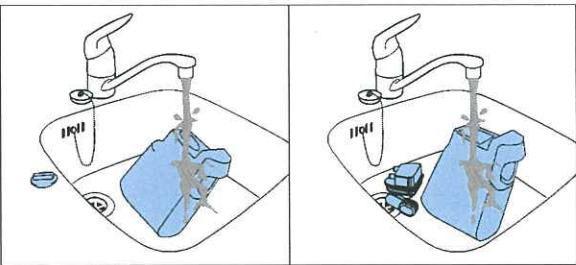

To remove and install the clean water tank, refer to Section 5.3 Fill the Clean Water Tank. To remove and install the dirty water tank, refer to Section 6.4 Empty the Dirty Water Tank.

The cap of the clean/dirty water tank can be rinsed under the tap.

**Note: The clean and dirty water tank should be emptied after each use, to prevent bacteria and odor buildup.**

### 7.3 Clean the Brush Roller

- ① To remove and install the brush roller, refer to Section 9.1 Replace the Brush Roller.
- ② Cut tangled items such as hair from the brush roller.
- ③ Clean the brush roller with clean water (mixing with some cleaning solution is recommended).

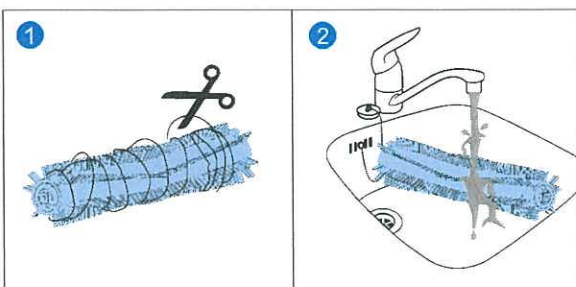

- ④ Put the brush roller on the bracket of the base dock to dry.

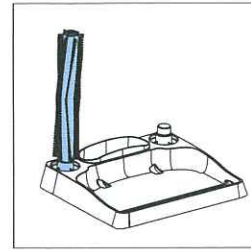

### 7.4 Cleaning the polymer roller

**Method 1:** Automatic Self-cleaning.

- ① Fill the clean water tank and empty the dirty water tank (add some Hizero cleaning solution to the fresh water tank) and re-install them. Now in the upright locking position remove the Hizero from the docking station and tip and rest as indicated below.
- ② Start the product and switch to Mode 2. Leave the product to run by itself until the clean water tank is empty.
- ③ For a better result we recommend to always use Hizero Cleaning Solutions.

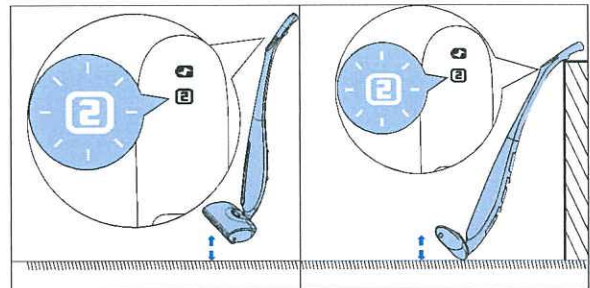

**Note: The clean and dirty water tank should be emptied after each use, to prevent bacteria and odor buildup.**

**Method 2:** Manual cleaning

Refer to section 9.2 Remove the cleaning roller and gently wash under a running tap.

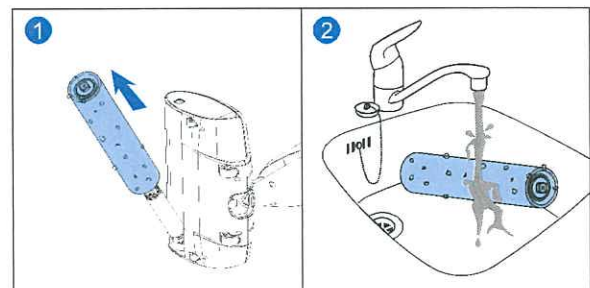

**Note: The clean and dirty water tank should be emptied after each use, to prevent bacteria and odor buildup.**

If your Hizero will not be used for more than 3 months, it is recommended to remove the cleaning roller, and place it on the dock. This will help it keep shape and remove odor.

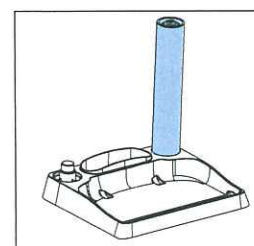

## 7.5 Clean the Trash Container

Remove the container (image 1), first empty it then wash it under a tap. (Unless you have our Hizero waste liner collectors, which you simply throw in the bin)

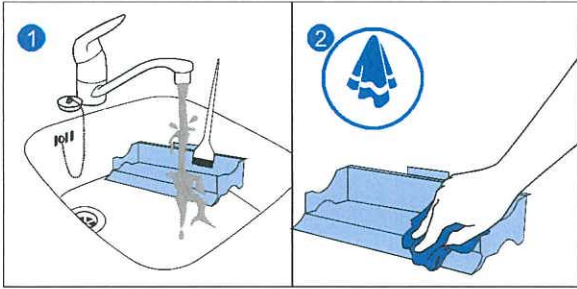

## 7.6 Cleaning the Brush Head

1 Open the exterior lid by pressing the silver button. Then press the release button, after that simply pull the brush head towards you to release.

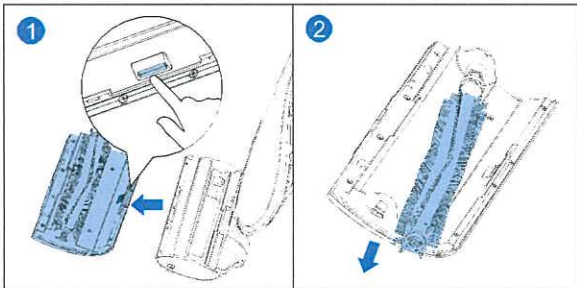

2 Clean the interior with a dampened cloth or tissue. Remove all hair from the brush using a pair of scissors.

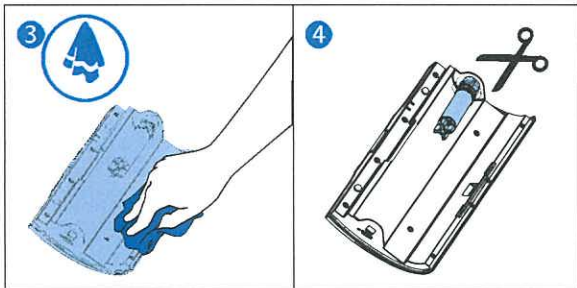

3 Reinstall the brush roller onto the lid, and install the lid back to the cleaning head.

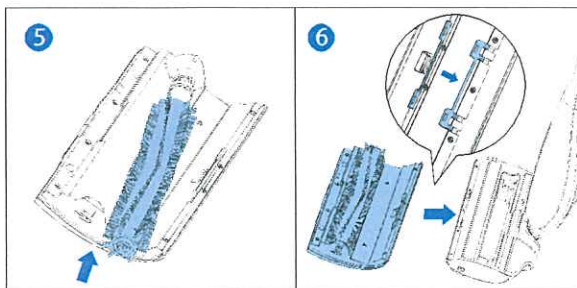

## 7.7 Clean the Grate

1 Open exterior lid, remove solid waste container (green one), remove comb filter (small green one), and remove Polymer roller (see Section 9.2 Replace the cleaning roller).

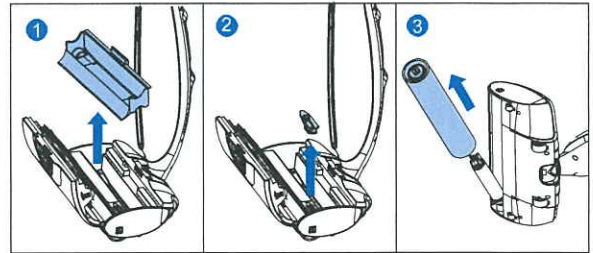

2 Press brush handle into comb filter location, push down to remove the grate (stainless steel in colour)

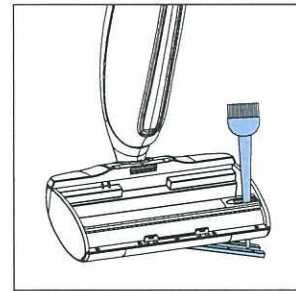

3 Clean both the grate and the comb filter in water, use detergent if necessary.

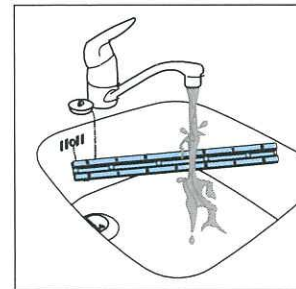

4 Re-install both the grate and the comb filter as per below. Make sure the alignment arrows match.

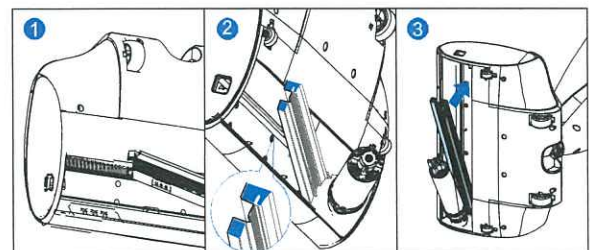

5 Finish the rest of the installation steps.

## 7.8 Clean/Replace the Comb Filter

- 1 Remove the Green comb filter.

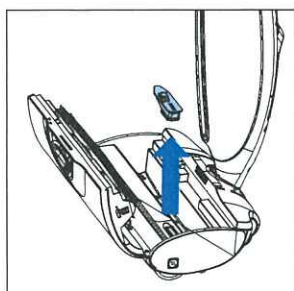

- 2 Either replace or clean depending on the condition of it.

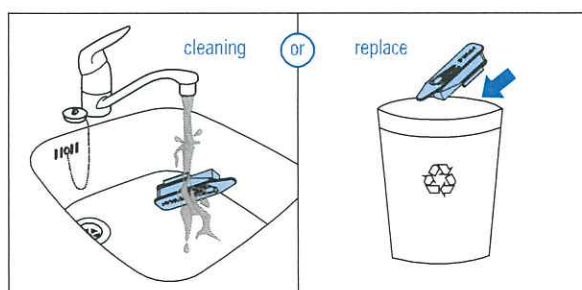

- 3 Put back the Comb Filter.

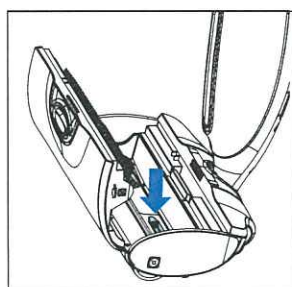

## 8. Storing & Moving

### 8.1 Storing

- 1 Before storing, switch off the product, lock the body and place it onto the base dock.
- 2 Please clean the inside of the cleaning head before storing to avoid odor.
- 3 Before storing, make sure the water tanks are empty.
- 4 If the product will not be used for not over a week, disconnect the power cable, and take out the cleaning roller to dry it before storing the product.

### 8.2 Moving

- 1 Make sure the product is switched off and locked in upright position.
- 2 To move the product, tilt the product backwards to use the back wheels.

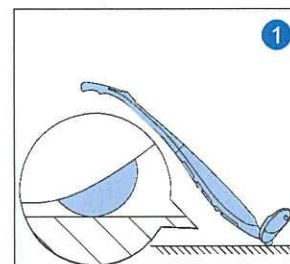

**Note:** If there is sand or other sharp objects on the floor, do not move the product with the wheels to avoid possible scratches.

## 9. Replacing Rollers

### 9.1 Replacing the Brush Roller

For best cleaning results, it is recommended to monitor the condition of the brush roller. When the bristles start to deform or loosen, please replace the brush roller. We recommend to only use HZERO replacement rollers.

- 1 Switch off the product and lock it in an upright position.
- 2 Open the cleaning head lid, and press the square button on the right hand side to take out the brush roller. (Maximum open angle of the drive motor is 30°. Please proceed with care to avoid damages.)

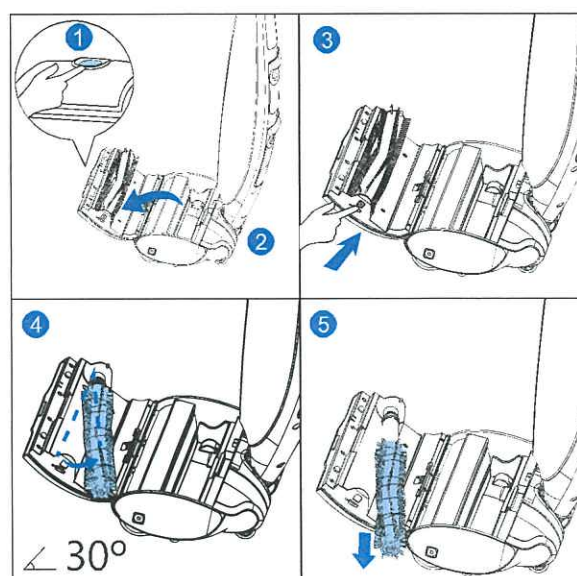



- ③ Insert the brush head roller, until it stops in position. The push it into the body of the Hizero, it is installed correctly when you hear a click sound. If the Hizero flashes red during operation please check that brush head is in place properly.

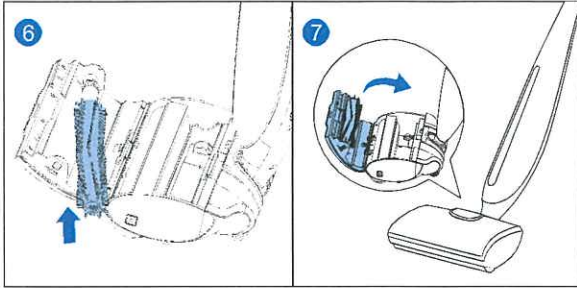

**Note:** The maximum open angle of the drive motor is 30°. Please proceed with care.

### 9.2 Replace the Cleaning Roller

For best results it is recommended the Polymer roller is changed every 6 months. To determine whether a roller needs to be changed check if it worn out or inconsistent in it's appearance. If it requires replacing, contact your Hizero Service center for a new one (Charges apply).

- ① Switch off the product, empty or take out the water tanks, and remove the trash container.
- ② Put the product on its side on flat floor with the square button facing top. Press the lateral square button to take the cleaning roller out.

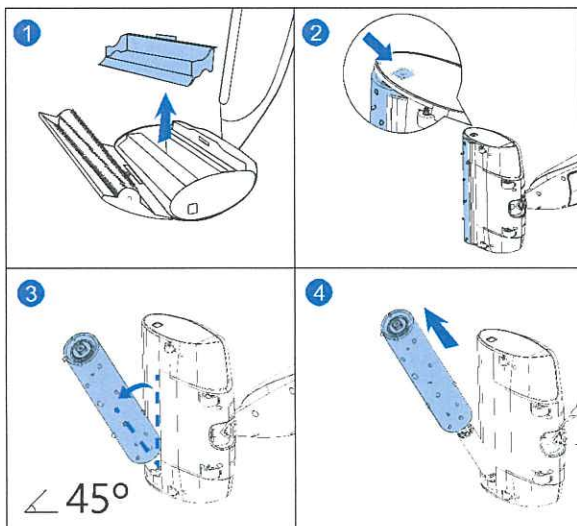

- ③ Insert a new cleaning roller onto the drive motor, push and fix it into the cleaning head till the lateral button is in place.

To install a new cleaning roller, refer to Section 4 Assembly.

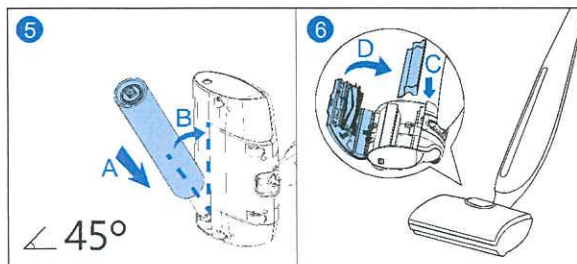

**Note:** 1.The Maximum open angle of the drive motor is 45°, please proceed with care.  
2.The used cleaning/brush roller is classified as plastic waste, please check your local environmental protection regulations before disposing the used cleaning roller.

## 10. Caring for the Environment

When the product reaches its service life, it is highly recommended to take the product to the local recycle station to contribute to the environment preservation.

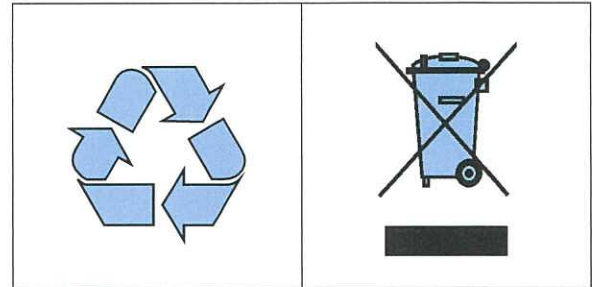

## 11. Specifications

Power Adapter Input	100–240V ~ 50/60 Hz 0.6A
Power Adapter Output	24.0 V ---1.0 A 24.0W
Appliance Power Rating	Refer to nameplate
Operating Voltage	18.25 VDC
Battery	Li-ion 2150mAh
Water Tank Volume	Clean water tank: 500 ml Dirty water tank: 500 ml
Net Weight	3.9 kg

## 12. Warranty & After-sales

For the detailed information of warranty and after-sales service, please visit our website: [www.hizero.com](http://www.hizero.com) or contact HIZERO Customer Service Centre in your country/region.

Your Bionic Floor Cleaner has been designed and developed with the greatest possible care. In the unfortunate case that the product needs repair, the Customer Service Centre in your country/region will help you by arranging any necessary repairs in the shortest possible time with maximum convenience.



Hizero Technologies Co., Ltd. will not be liable for any damage resulting from improper use or disassembly by customers.

## 13. Troubleshooting

This chapter summarizes the most common problems you could encounter using the product. If you are unable to solve the problem with the information below, please contact the Customer Service Center in your country/region or visit our FAQ page on [www.hizero.com](http://www.hizero.com).

Problems	Possible Causes	Solutions
The product leaks water	A. The cleaning roller is not completely soft.	Refer to Section 2 Assembling for the instruction about soaking and softening the cleaning roller. Note: squeeze excess water before installing.
	B. The cleaning roller is deformed or installed incorrectly.	Check the cleaning roller and its lateral button on the side to see whether there is a misplacement or deformation. If so, reinstall or replace the cleaning roller.
	C. The comb filter is clogged.	Clean or replace the comb filter. Refer to Section 7.8 Clean/Replace the Comb Filter.
	D. The grate is clogged.	Remove and clean. Refer to Section 7.7 Clean the Grate.
The product fails to start.	A. The battery has run out.	Charge the product and try again.
	B. The upper body and the lower body of the appliance are not assembled properly.	Reassemble the upper body and the lower body of the product and try again.
	C. The battery is not inserted properly.	Reinsert the battery.
The brush roller status indicator flashes in red.	The cleaning head lid is not completely closed.	Check the cleaning head lid to see whether it is open and if so, close it firmly.
The dirty water tank indicator flashes in red while there is no liquid in it.	The dirty water tank is not assembled correctly.	Reinstall the dirty water tank.
Product fails to start for self-cleaning while the product is on the base.	The power adapter is not disconnected.	Unplug the power adapter since the product will not start while charging.
There is foam left in the trash container.	Some detergent other than HIZERO original cleaning solution was used or too much HIZERO cleaning solution was added.	It is recommended to use HIZERO original cleaning solution ONLY. Please DO NOT use third party detergents to avoid possible damages to the product. Please note the recommended cleaning solution dosage in the instruction of the cleaning solution.

Hizero Technologies Co., Ltd.

Address: 1401-1402, Keenstar Building, Chuangye 2nd Rd., Baoan District, Shenzhen, China, 518101

Hizero Inc.

2E Valley Blvd, STE 280, Alhambra, CA 91801 USA

# HIZERO

[www.hizero.com](http://www.hizero.com)

\* 注：此页面无需印刷

产品物料标签			
产品名称	英简繁说明书	HIZERO 赫兹科技有限公司	
产品型号	F803	审核时间	
产品尺寸	A4	审核人员	
物料编号	M8900002302	设计时间	2021.5.26
图纸版本号	V05	设计人员	陈迪武
工艺要求	封面 128g 铜板纸，四色印刷 内页 80g 轻型纸，专色印刷 骑马钉 装订，正反面印刷	其他补充	